

# MATERIAL HANDLING

## Proof Test Load Tables for Marine Anchors

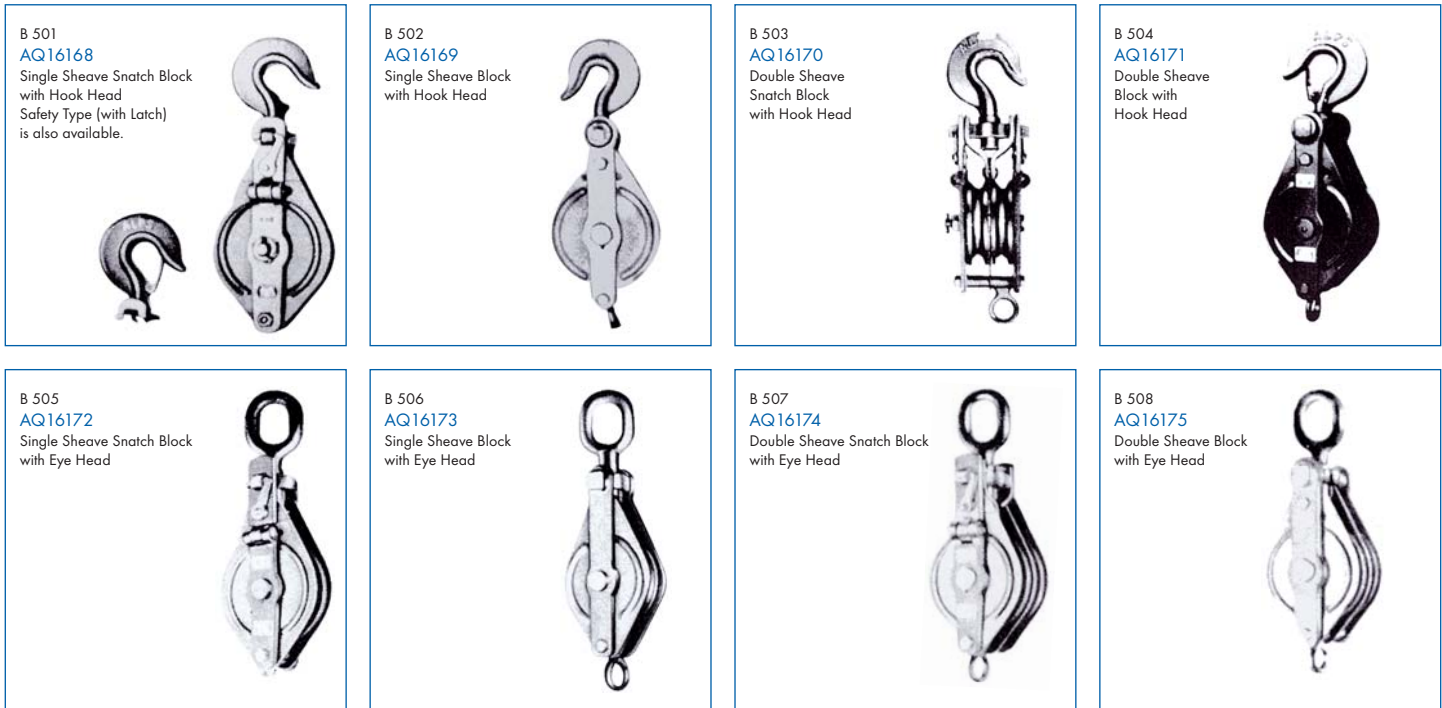

B501 ~ 508 Sizes and Weights (Approx.)

Sheave Dia		Dia of Wire Rope Applied	Pin Dia	Safe Working Load	Maximum Load	Test Load	Weight / pce			
m/m	in	m/m	m/m	kg	kg	kg	B501, B505	B502, B506	B503, B507	B504, B508
75	3	5~10	13	500	1000	1500	1.2	1.2	1.8	1.7
100	4	6~12	16	750	1500	2250	2.2	2.0	3.0	3.0
130	5	6~13	19	1500	3000	4500	4.0	4.2	6.0	6.0
150	6	8~16	27	2500	5000	7500	7.1	7.2	10.5	10.0
180	7	9~19	30	3000	6000	9000	10.8	10.5	15.5	15.0
200	8	12~20	37	4000	8000	12000	14.5	14.5	20.0	20.5
250	10	12~22	40	5000	10000	15000	20.4	23.5	36.0	33.5
300	12	14~25	45	6000	12000	18000	30.5	35.0	56.0	56.0
350	14	16~28	50	6500	13000	19500	50.0	52.0	80.0	64.0
400	16	16~30	55	7500	15000	22500	77.0	75.0	100.0	121.0

## Wire Rope Block (with Ball bearing)



Sheave Dia	150m/m	200m/m
Weight/pce	15kg	33kg
S.W.L	7.5 Tons	10 Tons

B518~519 Size and Weights (Approx.)

Sheave Dia		Dia of Wire Rope Applied	S.W.L (T)				w/pce kg			
m/m	in	m/m	B518		B519		B518H		B519H	
			Shackle Type	Swivel Type	Shackle Type	Swivel Type	Shackle Type	Swivel Type		
75	3	4~9	0.5	-	-	-	1.2	-	-	-
100	4	4~9	1	1	1	1	1.8	2.8	1.8	3.0
125	5	4~12	1.5	1.5	1	1.5	3.6	5.5	3.6	6.1
150	6	4~14	2	2	1.5	2	6.0	8.5	6.0	9.4
175	7	4~16	3	3	2	2.5	9.0	13.8	9.0	14.4
200	8	4~16	3.5	3.5	2	2.5	11.7	18.0	11.7	18.7
250	10	4~16	4	4	2	-	15.0	-	15.0	-
300	12	4~16	4.5	4.5	-	-	17.6	-	-	-
375	15	4~16	5	5	-	-	27.0	-	-	-

2S: 2 Sheave 1S: 1 Sheave (Hook Head is available)

### Allinton Engineering & Trading Pte Ltd

Head Office: Block 803, King George's Avenue #01-234 Singapore 200803. Tel: 6296 0679 (10 lines) 6292 7728 Fax: 6297 0024

Branch Office: 21 Tuas Basin Link Singapore 638782 Tel: 6265 1888 (10 lines) Fax: 6265 5623

Web-site: <http://www.allinton.com.sg> E-mail: [allinton@singnet.com.sg](mailto:allinton@singnet.com.sg)

# MATERIAL HANDLING

## Galvanised Malleable Iron Blocks

Sizes from 2 inch to 12 inch



No. 17  
AQ16183



No. 18  
AQ16184



No. 22  
AQ16185



No. 23  
AQ16186



No. 28  
AQ6187

### SINGLE, DOUBLE AND TREBLE BLOCKS

Nominal		Length		Sheaves		Circ of Fibre Rope		SINGLE		DOUBLE		TREBLE	
Size of Block		of Shell		Dia x Width		for Standard Sheaves		No. 17 Swivel Eye	No. 18 Swivel Hook	No. 22 Swivel Eye	No. 23 Swivel Hook	No. 27 Swivel Eye	No. 28 Swivel Hook
in	mm	in	mm	in	mm					Safe Working Load in Tons			
3	76	3 1/2	88	1 3/4 x 3/8	44 x 16	1 1/2	38	0.2	0.1	0.4	0.3	0.5	0.3
4	102	4 3/4	121	2 3/4 x 3/4	60 x 19	2	51	0.4	0.2	0.9	0.5	1.0	0.5
5	127	5 3/4	146	3 1/4 x 7/8	82 x 22	2 1/4	57	0.5	0.3	1.1	0.8	1.5	0.8
6	152	7	177	3 3/4 x 1 1/4	95 x 31	3	76	1.0	0.5	2.0	1.1	2.0	1.3
7	177	8	203	4 3/8 x 1 1/4	111 x 31	3 1/4	82	1.1	0.6	2.3	1.3	2.4	1.5
8	203	9 1/4	235	5 3/8 x 1 3/8	137 x 38	3 1/2	88	1.2	0.7	2.6	1.5	3.0	2.0
9	229	10	254	6 1/4 x 1 1/2	159 x 38	3 3/4	95	1.5	0.9	3.0	2.0	3.5	2.5

- Much stronger than wood blocks of equivalent size.
- Edges beaded to prevent chafing of rope.
- Fitted with hooks or eyes as required.

- Sheaves Iron castings with smooth grooves, plain bore
- Pins Cottered to prevent rotation or accidental removal
- Bushes (When specified) sintered bronze oil retaining.

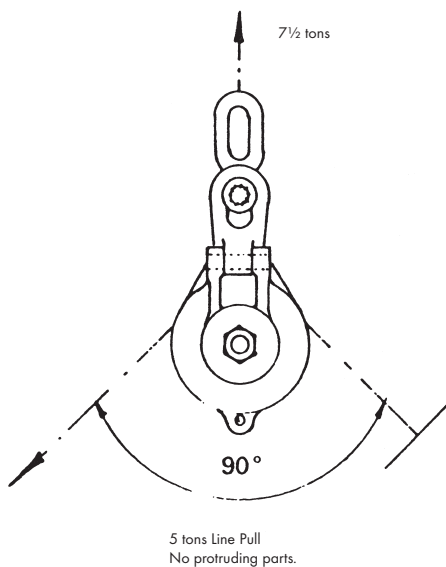

AQ16188

### Logging Snatch Block

SHEAVE: 6 in (150 mm) outside diameter for 3/4" (19 mm) diameter wire rope shrouded by ample rope guards.

LUBRICATION: via grease nipple countersunk into sheave pin head, feeding into large grease chamber.

HEADFITTING: Swivel Oval Eye (as illustrated) or with Swivel Hook.

Suitable for Line Pull of 5 tons. = 7 1/2 tons on headfitting (neglecting friction) at 90° wrap. As sketch - Tested to 15 tons.

### Allinton Engineering & Trading Pte Ltd

Head Office: Block 803, King George's Avenue #01-234 Singapore 200803. Tel: 6296 0679 (10 lines) 6292 7728 Fax: 6297 0024

Branch Office: 21 Tuas Basin Link Singapore 638782 Tel: 6265 1888 (10 lines) Fax: 6265 5623

Web-site: <http://www.allinton.com.sg> E-mail: [allinton@singnet.com.sg](mailto:allinton@singnet.com.sg)

# MATERIAL HANDLING

## Blocks

### Snatch Block

AQ01435

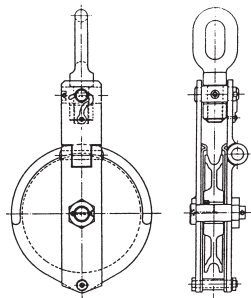

#### General Purpose

Code No	Sheave Dia. (mm)	Wire Rope Dia (mm)	SWL (ton)	Test (ton)	Weight (kg)
AQ01435	10" (250)	18-20	3	12	40
AQ01436	12" (300)	20-24	5	20	46
AQ01437	14" (350)	24-28	6	24	65
AQ01438	16" (400)	29-32	8	32	98

AQ01439

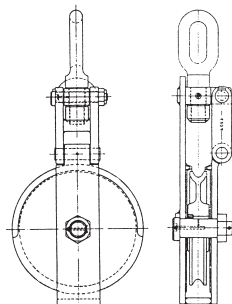

#### Heavy Duty

Code No	Sheave Dia. (mm)	Wire Rope Dia (mm)	SWL (ton)	Test (ton)	Weight (kg)
AQ01439	16" (400)	29-32	10	40	104
AQ01440	18" (460)	32-36	15	60	153
AQ01441	18" (460)	38-42	20	80	204
AQ01442	20" (500)	38-42	25	90	230

### Hoisting Block – Single Sheave

AQ01457

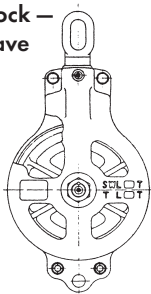

### 2 Sheave

AQ01466

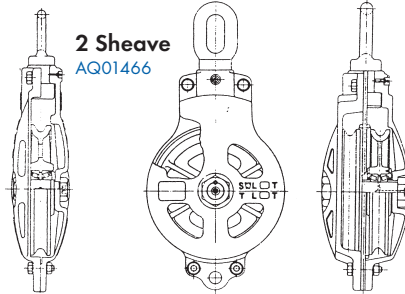

#### Single Sheave AP-211

Code No	Sheave Dia. (mm)	Wire Rope Dia (mm)	SWL (ton)	Test (ton)	Weight (kg)
AQ01457	150	10-13	2	8	11
AQ01458	200	16-20	3	12	20
AQ01459	250	16-20	3	12	27
AQ01460	300	20-22	5	20	40
AQ01461	340	18-20	5	20	55
AQ01462	410	22-24	10	30	68
AQ01463	430	23-25	16	38	98
AQ01464	460	24-26	20	45	136
AQ01465	480	26-28	20	55	198

#### 2 Sheave AP-221

Code No	Sheave Dia. (mm)	Wire Rope Dia (mm)	SWL (ton)	Test (ton)	Weight (kg)
AQ01466	340	18-20	16	26	105
AQ01467	410	20-22	20	40	156
AQ01468	430	22-25	24	48	213
AQ01469	460	24-26	27	47	283
AQ01470	480	26-28	30	55	365

### Heel Block – Single Sheave

AQ01443

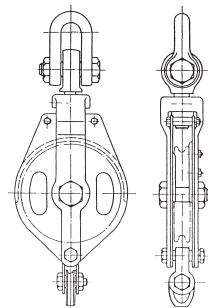

### 2 Sheave

AQ01450

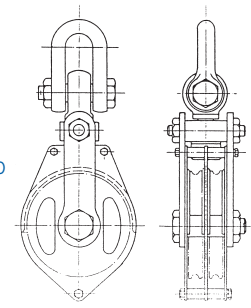

#### Single Sheave HB-311

Code No	Sheave Dia. (mm)	Wire Rope Dia (mm)	SWL (ton)	Test (ton)	Weight (kg)
AQ01443	8" (200)	9-12	1	4	22
AQ01444	10" (250)	14-16	3	12	28
AQ01445	12" (300)	16-21	5	20	33
AQ01446	14" (350)	21-24	5	20	42
AQ01447	14" (350)	24-29	8	32	50
AQ01448	16" (400)	29-32	10	40	74
AQ01449	18" (450)	32-36	15	60	110

#### 2 Sheave with Becket HB-312

Code No	Sheave Dia. (mm)	Wire Rope Dia (mm)	SWL (ton)	Test (ton)	Weight (kg)
AQ01450	8" (200)	9-12	1	6	26
AQ01451	10" (250)	14-16	3	18	33
AQ01452	12" (300)	16-21	5	30	38
AQ01453	14" (350)	21-24	5	30	49
AQ01454	14" (350)	24-29	8	48	58
AQ01455	16" (400)	29-32	10	60	86
AQ01456	18" (450)	32-36	15	90	129

### Heel Block – 2 Sheave

AQ01471

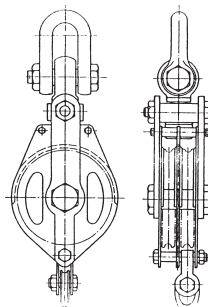

### 3 Sheave

AQ01481

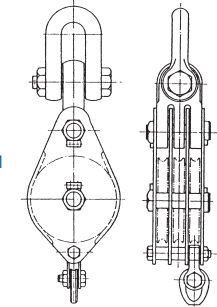

#### 2 Sheave with Becket HB-322

Code No	Sheave Dia. (mm)	Wire Rope Dia (mm)	SWL (ton)	Test (ton)	Weight (kg)
AQ01471	10" (250)	14-16	6	12	54
AQ01472	10" (250)	16-20	10	20	67
AQ01473	12" (300)	16-20	10	20	73
AQ01474	12" (300)	20-24	15	30	94
AQ01475	14" (350)	20-24	20	40	120
AQ01476	16" (400)	24-28	25	50	161
AQ01477	16" (400)	28-32	30	50	186
AQ01478	16" (400)	28-32	40	80	213
AQ01479	18" (450)	28-32	25	50	209
AQ01480	18" (450)	28-32	30	60	236

#### 3 Sheave with Becket HB-332

Code No	Sheave Dia. (mm)	Wire Rope Dia (mm)	SWL (ton)	Test (ton)	Weight (kg)
AQ01481	10" (250)	14-16	10	30	74
AQ01482	10" (250)	16-20	15	35	86
AQ01483	12" (300)	16-20	15	35	117
AQ01484	12" (300)	20-24	20	40	141
AQ01485	14" (350)	20-24	25	45	176
AQ01486	14" (350)	24-28	30	50	200
AQ01487	16" (400)	24-28	30	50	234
AQ01488	16" (400)	28-32	40	60	258
AQ01489	18" (450)	28-32	40	60	300

## Allinton Engineering & Trading Pte Ltd

Head Office: Block 803, King George's Avenue #01-234 Singapore 200803. Tel: 6296 0679 (10 lines) 6292 7728 Fax: 6297 0024

Branch Office: 21 Tuas Basin Link Singapore 638782 Tel: 6265 1888 (10 lines) Fax: 6265 5623

Web-site: <http://www.allinton.com.sg> E-mail: [allinton@singnet.com.sg](mailto:allinton@singnet.com.sg)